

SPEED QUEEN ON-PREMISES LAUNDRY

FRONT CONTROL LDEE5BGS173TW01, LDEE5BGS153TW01, LDGE5BGS113TW01 SINGLE DRYER

Single Dryers

With an easy-to-clean large lint compartment and a reversible door to accommodate your laundry design, Speed Queen® single dryers are designed to suit your laundry's specific needs. The 2.06 sq. ft. door opening is the largest in the industry, providing easy loading and unloading.

- Durable galvanized steel cylinder with an extra-large 7 cu. ft. of volume.
- Efficient dryer heating with 22,500 Btu (gas models) and 5350 Watts (electric models).

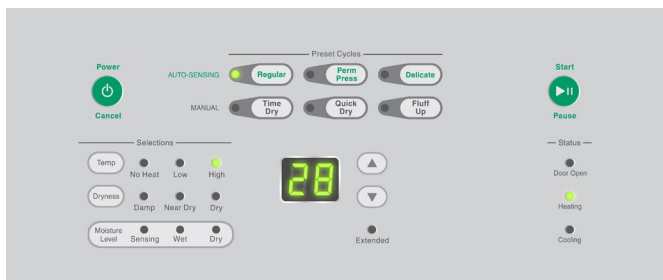

Electronic Homestyle

Speed Queen® dryers with Electronic Homestyle controls are designed for durability and are easy to operate with intuitive selection buttons and cycle status indicator lights. This control option features a time-remaining display, six preset cycle buttons, cycle adjustability for temperature and load size.

SPECIFICATIONS

SINGLE DRYER

MODEL	LDEE5BGS173TW01, LDEE5BGS153TW01, LDGE5BGS113TW01	
CONTROL OPTION	Electronic Homestyle	
CONTROL LOCATION	Front	
CAPACITY - lb (kg)	18 (8.2)	
CYLINDER VOLUME - cu. ft. (liters)	7.0 (198)	
OVERALL WIDTH - in (mm)	26.875 (683)	
OVERALL DEPTH - in (mm)	28 (711)	
OVERALL HEIGHT - in (mm)	40.42 (1027)	
MOTOR POWER CONSUMPTION - hp (kw)	0.33 (0.25)	
AVAILABLE HEAT SOURCES	Gas or Electric	
AVAILABLE HEATING ELEMENT (Electric W)	5350 @ 240V	
GAS INLET CONNECTION - in (mm)	3/8 (9.5)	
GAS CONSUMPTION - BTU/Hr	22,500	
EXHAUST OUTLET DIA. - in (mm)	4 (102)	
EXHAUST AIRFLOW - cfm (liters/sec)	220 (105)	
*AVAILABLE CYCLES	Regular, Perm Press, Delicate, Time Dry, Quick Dry, Fluff Up	
CYCLE INDICATOR LIGHTS	Yes	
CYLINDER FINISH	Galvanized	
AVAILABLE COLORS	White	
DOOR TYPE (Solid/Window)	Solid	
AVAILABLE ELECTRICAL REQUIREMENTS - Voltage/Hz/Ph - Circuit Amperage	Electric	120/240/60/1 -30
	Gas	120/60/1 - 15
SHIPPING DIMENSIONS APPROX. - in (mm)	Width	29.5 (749)
	Depth	30.5 (775)
	Height	45 (1143)
NET WEIGHT - lb (kg)	Electric	126 (57)
	Gas	140 (64)
SHIPPING WEIGHT - lb (kg)	Electric	136 (62)
	Gas	130 (59)
AGENCY APPROVALS	Electric	cULus
	Gas	cCSAus

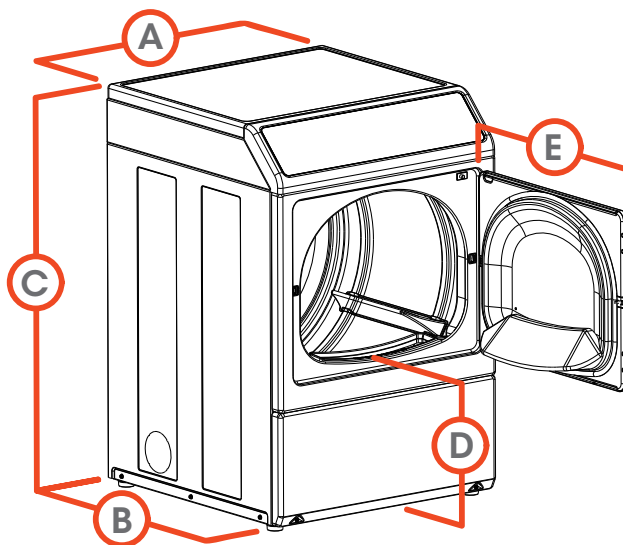

A.	OVERALL WIDTH - in (mm)	26.875 (683)
B.	OVERALL DEPTH - in (mm)	28 (711)
C.	OVERALL HEIGHT - in (mm)	40.42 (1027)
D.	FLOOR TO DOOR OPENING - in (mm)	15.44 (392)
E.	DOOR SWING - in (mm)	23.5 (597)

ADA Compliant

Note: Not all options are available for all models. Refer to the price list for the available models and options.

* Information shown applies to highest end control available.

For the most accurate information, the installation guide should be used for all design and construction purposes. Due to continuous product improvements, design and specifications subject to change without notice. The quality management system of Alliance Laundry Systems' Ripon facility has been registered to ISO 9001:2008.