

ON-PREMISES
RIGID MOUNT WASHER EXTRACTOR

PA40

40lb

PA
RANGE



FEATURES

- Rigid mounted, 100 or 200 G-Force options
- Stainless steel top, front, and side panels
- Stainless steel cylinder and tub
- Patented Cascade™ cylinder for better washability
- XControl+ – fully programmable control
- Patented soap hopper
- Large drain valve
- Front access to vital parts for easy maintenance
- Large door opening for easy loading and unloading
- USB plug on the back panel and control board
- Warranty: First three years on all parts; First five years frame and cylinder shaft assembly; First five years on cylinder bearings and bearing seals (*parts only*)

OPTIONS

- Third water inlet
- Steam heating



ERGONOMICAL
CONSTRUCTION



LARGE DOOR
OPENING



LOW WATER
AND ENERGY
CONSUMPTION



3 YEAR PARTS
WARRANTY

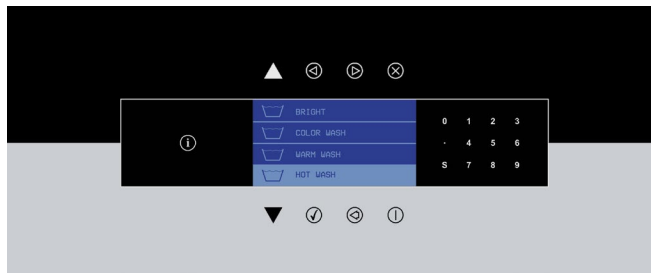

GET AHEAD IN LAUNDRY

MODEL		PA40
CONTROL OPTION		XControl+
CAPACITY - lb (kg)		40 (18)
OVERALL WIDTH - in (mm)		35.03 (890)
OVERALL DEPTH - in (mm)		36.02 (915)
OVERALL HEIGHT - in (mm)		55.51 (1410)
CYLINDER DIAMETER - in (mm)		29.53 (750)
CYLINDER VOLUME - cu. ft. (liters)		6.4 (181)
DOOR OPENING SIZE - in (mm)		18.11 (460)
DOOR BOTTOM TO FLOOR - in (mm)		18.31 (465)
WASH SPEED - RPM		42
EXTRACT SPEED - RPM		490/690
EXTRACT G-FORCE		100 or 200
STEAM HEATING - psi		15-116
SOUND PRESSURE LEVEL - dB (A)		< 65
WATER VALVE CONNECTION - NPT*		0.75"
WATER PRESSURE -psi		15-116
RECOMMENDED WATER PRESSURE - psi		44-73
WATER INLET (EACH) - g/min		5.28
DRAIN VALVE - in (mm)		3 (76)
FLOW AMOUNT W/ DRAIN VALVE - g/min		55.48
FLOOR TO DRAIN OUTLET CENTER - in (mm)		5.12 (130)
SIDE TO DRAIN OUTLET CENTER - in (mm)		11.02 (280)
STEAM VALVE CONNECTION - BSP		0.5"
VOLTAGE/CIRCUIT BREAKER - FLA 208-240/60/1		15-9.1
SHIPPING DIMENSIONS APPROX. - in (mm)		Width 36.42 (925) Depth 38.19 (970) Height 61.02 (1550)
NET WEIGHT - lb (kg)		100/200 563/695 (255/315)
SHIPPING WEIGHT - lb (kg)		100/200 595/739 (270/335)
AGENCY APPROVALS		cCSAus

*Fill hoses provided to convert BSP at machine to NPT supply connection.

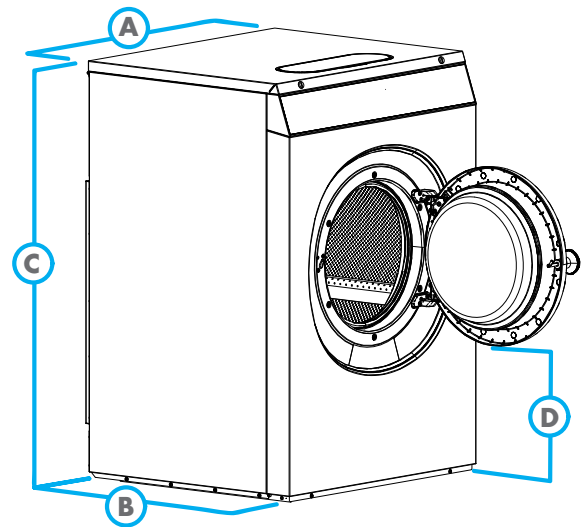

DIMENSIONS	PA40
A. OVERALL WIDTH - in (mm)	35.03 (890)
B. OVERALL DEPTH - in (mm)	36.02 (915)
C. OVERALL HEIGHT - in (mm)	55.51 (1410)
D. DOOR BOTTOM TO FLOOR - in (mm)	18.31 (465)

AY18-0095

For the most accurate information, the installation guide should be used for all design and construction purposes. Due to continuous product improvements, design and specifications subject to change without notice. The quality management system of Alliance Laundry Systems' Ripon facility has been registered to ISO 9001:2008.

© 2018 Alliance Laundry Systems LLC

www.primuslaundry.com

primus

by Alliance Laundry Systems