

On-Premises 25-lb Softmount Washer-Extractor



Maximized throughput, minimized costs. That's what busy on-premises laundries demand. Huebsch® softmount washer-extractors deliver those results, while producing exceptional finished wash quality. In addition, their durability ensures the machines will be consistent laundry performers for years to come.

Strength

A heavy-duty suspension system absorbs vibrations without the need for special foundations. Reinforced stainless steel side panels and oversized door and hinges contribute to durability and a long life for the machine.

Power

High G-Force extraction speeds of between 350 and 400 G-Force deliver exceptional power to remove more water from loads and reduce drying time – combining for increased throughput.

Performance

Available in a variety of capacities, including 20 lb, 25 lb, 30 lb, 40 lb, 55 lb, 70 lb, 90 lb and 125 lb Huebsch has a softmount washer-extractor model to meet the needs of any on-premises laundry.



HC200

The HC200 Control provides up to 99 cycle programs. Versatile and easy to use, the advanced computer control meets a variety of specialized needs. With more than 20 languages available, our HC200 is intuitive for bilingual operators. Users can easily follow the status of every phase of the wash cycle and modify data and parameters at any time to monitor for maximum efficiency.

On-Premises 25-lb Softmount Washer-Extractor Specifications

MODEL		HY025
CONTROL OPTION		HC200
CAPACITY - lb (kg)		25 (11)
OVERALL WIDTH - in (mm)		31.29 (795)
OVERALL DEPTH - in (mm)		31.29 (795)
OVERALL HEIGHT - in (mm)		48.22 (1225)
CYLINDER DIAMETER - in (mm)		24.40 (620)
CYLINDER DEPTH - in (mm)		13.78 (350)
CYLINDER VOLUME - cu. ft. (liters)		3.7 (105)
DOOR OPENING SIZE - in (mm)		16.14 (410)
DOOR BOTTOM TO FLOOR - in (mm)		13.46 (342)
WASH SPEED - RPM		49
EXTRACT SPEED - RPM		1075
EXTRACT G-FORCE		400
WATER INLET CONNECTION - in (mm)		2 x 0.75 (19)
STEAM INLET CONNECTION - in (mm)		0.5 (13)
DRAIN DIAMETER - in (mm)		3 (76)
MOTOR POWER CONSUMPTION - hp (kw)		1.48 (1.10)
VOLTAGE/ CIRCUIT BREAKER - FLA *	200-240/50/60/1/3**	15-9.8 (1 Ph) 15-9.8 (3 Ph)
SHIPPING DIMEN- SIONS APPROX. - in (mm)	Width	32.87 (835)
	Depth	33.01 (840)
	Height	52.95 (1345)
NET WEIGHT - lb (kg)		463 (210)
SHIPPING WEIGHT - lb (kg)		518 (235)
AGENCY APPROVALS		CSA

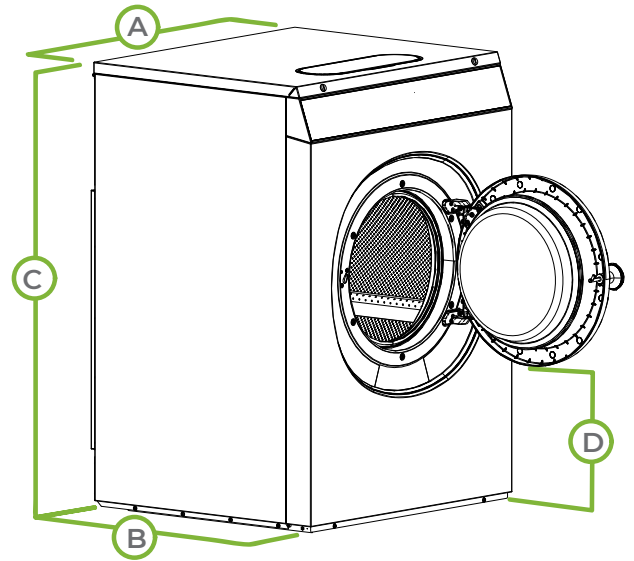

MODEL	HY025
A. OVERALL WIDTH - in (mm)	31.29 (795)
B. OVERALL DEPTH - in (mm)	31.29 (795)
C. OVERALL HEIGHT - in (mm)	48.22 (1225)
D. DOOR BOTTOM TO FLOOR - in (mm)	13.46 (342)

* Circuit breaker and amp draw data shown are for models without electric heat. Consult factory for other configurations. Manufacturing strongly recommends using a circuit breaker instead of fuses.

** Operates on single or three phase systems as single phase

For the most accurate information, the installation guide should be used for all design and construction purposes. Due to continuous product improvements, design and specifications subject to change without notice. The quality management system of Alliance Laundry Systems has been registered to ISO 9001.